

pco.dicam C4

intensified 16 bit **sCMOS** camera

**intensified
sCMOS**

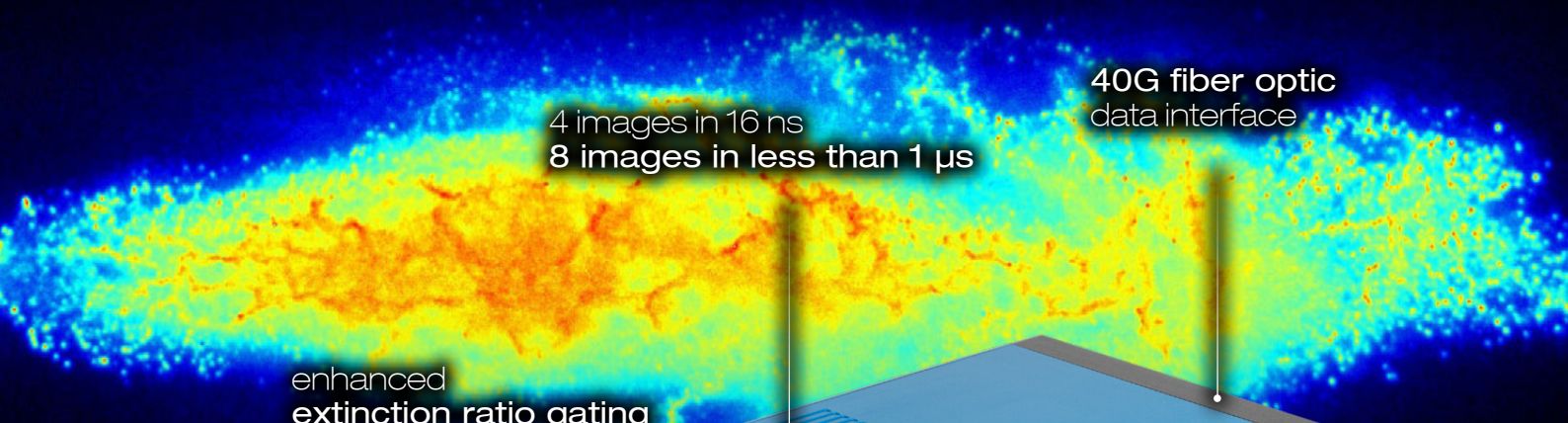

4 images in 16 ns
8 images in less than 1 μ s

40G fiber optic
data interface

enhanced
extinction ratio gating

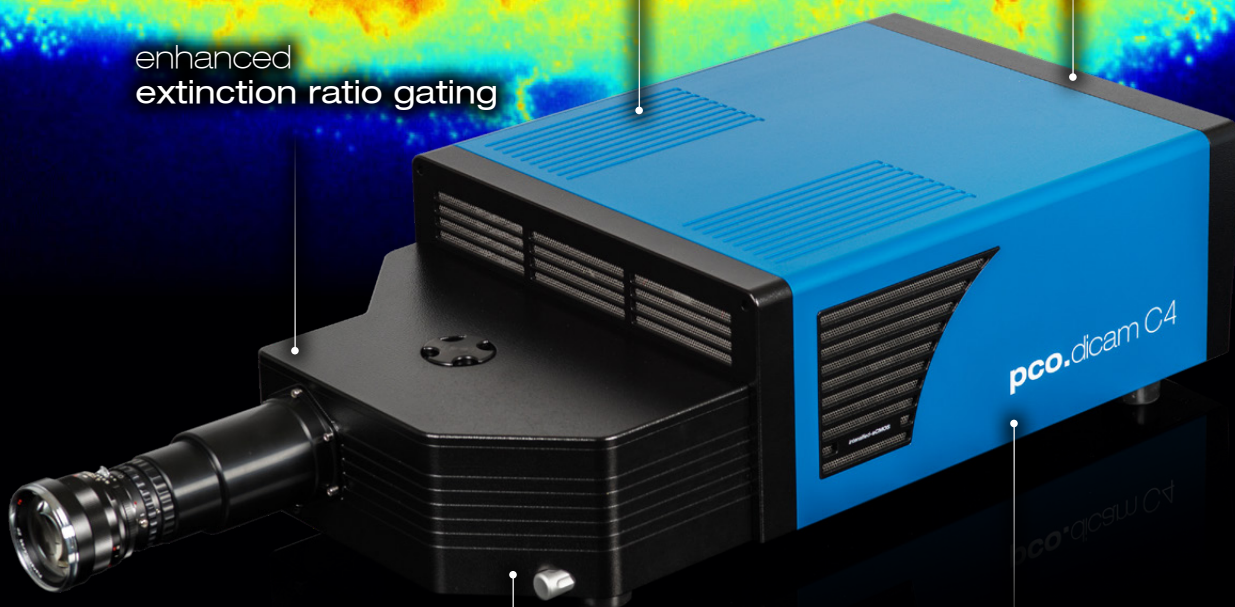

exposure time 4 ns
with 25 mm intensifier

intensified
sCMOS technology
2048 x 2048 pixel

pco.dicam C4

After more than 30 years of experience with image intensified cameras, we are proud to introduce the new pco.dicam C4 to you. The pco.dicam C4 is the first multi-channel intensified camera system which exploits the full performance inherent to scientific **CMOS** sensor technology.

With its high-end optical beam splitters you are able to equally distribute the input light to the 4 image intensifiers. They are coupled with the pco.dicam C1 proven tandem lenses to the 16 bit 4.2 Mpixel sCMOS sensor. It's the most flexible configuration of 8 individual exposure times and their corresponding interframing times, which makes the camera so unique. The 40G fiber optic based data interface guarantees you uncompressed and robust 16 bit data transfer of 424 full frames per second via optical fiber over virtually any distance.



feature & benefit

424 frames/s @ full 4.2 MPixel resolution	high frame rates at high resolution for imaging of dynamic processes
1.1 e⁻ readout noise	lowest readout noise of any gated intensified camera system
16 bit digitization	taking advantage of the higher dynamic range possible from high end image intensifiers
four 25 mm high resolution image intensifiers	doubles the optical resolution of conventional 18 mm image intensifiers
optical coupling via ultra-speed tandem lens	outstanding image quality with high transmission efficiency and no artifacts
tandem lens with 0.53 : 1 image scaling	full 25 mm diameter of intensifier output is lossless imaged onto sCMOS sensor
40G fiber optic based data interface	fiber optical interface virtually covers any distance without deploying additional interface converters or signal amplifiers with immunity to EMI
4 x 880 MByte/s image data rate	highest sustained image data rate of any intensified camera system on the market; no limitations for recording duration
double shutter mode with 300 ns interframing time	two consecutive full resolution images with a configurable minimum interframing time of 300 ns on each of the 4 channels
4.2 MPix sCMOS sensor	overcomes CCD limitations in terms of speed and sensitivity
enhanced extinction ratio gating	fast MCP gating for improved extinction ratio for the blue and uv part of the spectrum
additional optical trigger input	robust trigger transmission over long distance in EMC critical environments
EF lens control	convenient remote lens control for camera systems inaccessible during an experiment
selected highly homogeneous image intensifiers	uses best image intensifier quality available on the market
50 ns trigger to exposure start delay	ultra-fast camera reaction to trigger event
4 ns gating with 25 mm intensifier	captures fast transient phenomena
extensive and highly precise IN/OUT signaling	allows for perfect synchronization in any experimental set-up as timing master or slave
configurable delay in steps of 1 ns	flexible adaptation to synchronization needs

» top view

front part with optical input and beam splitter optics

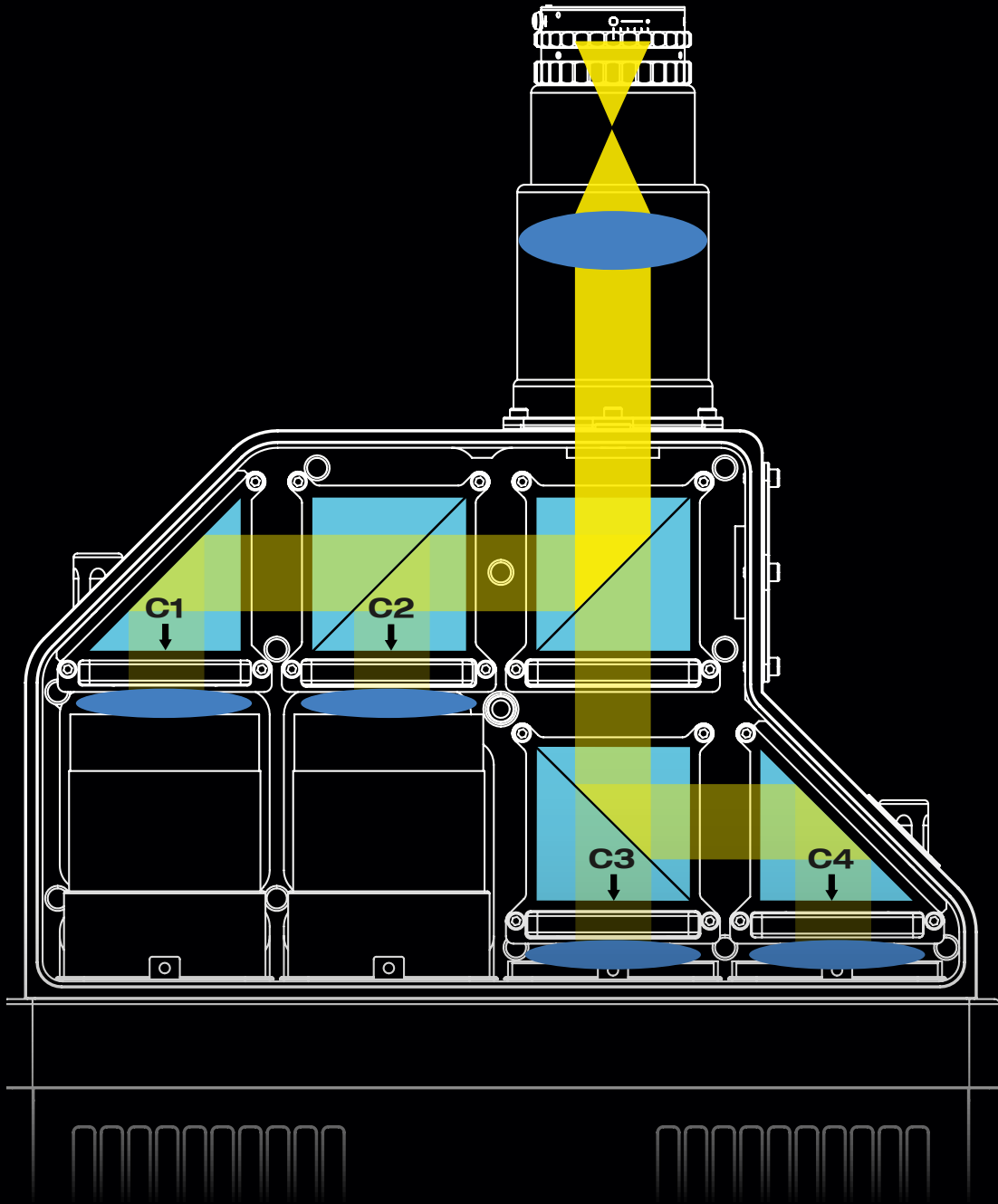

» sCMOS image sensor

Each detector unit of this unique 4 channel design is equipped with an sCMOS image sensor.

type of sensor	scientific CMOS (sCMOS)
resolution (h x v)	2048 x 2048 active pixel
pixel size (h x v)	6.5 µm x 6.5 µm
sensor format / diagonal	13.3 mm x 13.3 mm / 18.8 mm
shutter mode	single image double image
MTF¹	76.9 lp/mm (theoretical)
fullwell capacity	15 000 e ⁻ for P46 phosphor 30 000 e ⁻ for P43 phosphor
readout noise²	1.1 med / 1.5 rms e ⁻ single image 2.2 med / 2.5 rms e ⁻ double image
dynamic range	13 600 : 1 (82.7 dB) for P46 phosphor 27 200 : 1 (88.7 dB) for P43 phosphor
quantum efficiency	58 % for P43 peak emission @ 545 nm 57 % for P46 peak emission @ 530 nm
spectral range	300 nm ... 1000 nm
dark current³	< 0.6 e ⁻ /pixel/s @ 7 °C
DSNU	1.0 e ⁻ rms
PRNU	< 0.6 %
anti blooming factor	1 : 10 000

» perfect fit: phosphor emission vs. sCMOS quantum efficiency

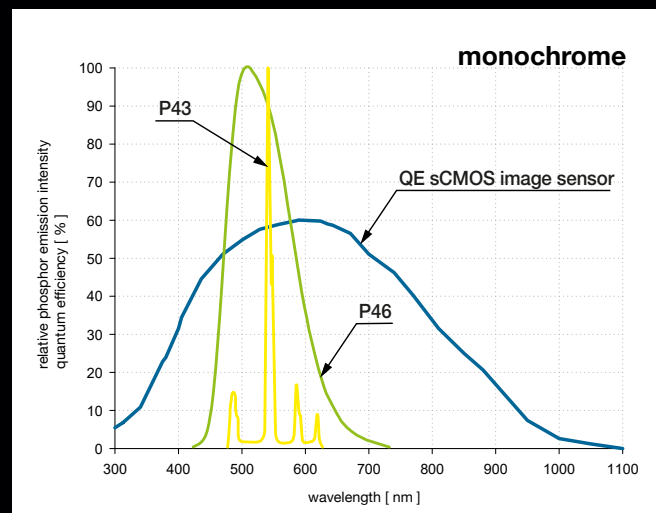

This chart describes the spectral situation for the internal imaging of the image intensifier's phosphor output screen to the sCMOS sensor of the camera detector module. This imaging is done by the highly efficient tandem lens system.

Please note: The spectral sensitivity relevant for your experiment is solely determined by the QE curve of the photocathode material of the image intensifier (page 8).

¹ Modulation transfer function

² The readout noise values are given as median (med) and root mean square (rms) values due to the different noise models, which can be used for evaluation. All values are raw data without any filtering.

³ Measurements with dark current compensation

» detector unit (4x)

maximum frame rate @ full resolution	106 fps
dynamic range A/D ⁴	16 bit
pixel scan rate	286.0 MHz
binning horizontal	x1, x2, x4
binning vertical	x1, x2, x4
region of interest (ROI)	horizontal: steps of 4 pixels vertical: steps of 1 pixel
non linearity	< 1 %
cooling method	+ 7 °C stabilized, 1 stage peltier with forced air (fan)
input signals	electrical trigger, arm input (TTL level, BNC connectors), gate disable (high-speed TTL input, BNC connectors)
output signals	gate/expos out monitor, user monitor output (TTL level, BNC connectors)
time stamp	in image (1 µs resolution)

» general camera system

power supply	110 - 230 V
power consumption	180 W
weight	43.3 kg
operating temperature	+ 10 °C ... + 40 °C
operating humidity range	10 % ... 80 % (non-condensing)
storage temperature range	- 10 °C ... + 60 °C
optical interface	F-mount optional: Canon mount
lens remote controller	electronic control for Canon EF lenses
input signals	master trigger electrical and optical
CE / FCC certified	yes

⁴ The high dynamic signal is simultaneously converted at high and low gain by two 11 bit A/D converters and the two 11 bit values are sophisticatedly merged into one 16 bit value.

» exposure modes

single image mode

exposure times 4, 10 ns fixed,
20 ns ... 250 ns (1 ns steps),
250 ns ... 1 s (10 ns steps)

delay times 0 ns ... 250 ns (1 ns steps),
250 ns ... 1 s (10 ns steps)

maximum repetition frequency 200 kHz sustained, 3.3 MHz burst

insertion delay

trigger input to exposure out 19 ns

trigger input to optical open 49 ns

jitter

trigger input to exposure out 35 ps rms

trigger input to optical open 150 ps rms

double image mode

exposure times 20 ns ... 1 ms (in 10 ns steps)

delay settings 0 ns ... 10 ms (in 10 ns steps)

interframing time 300 ns ... 10 ms (in 10 ns steps)
on every channel

» continuous imaging

2048 x 2048	424 fps
2048 x 256	up to 3200 fps
2048 x 16	> 27 000 fps

» frame rates

Due to the special 4 channel design of the pco.dicam C4 and the flexible timing possibilities, extremely high burst frame repetition rates are feasible. In single image mode you can record sequences of 4 ultra fast images and in double image mode sequences of 8 ultra fast images. Examples for such extreme frame repetition rates are given below.

single image mode 4 images of 4 ns exposure time
with 0 ns interframing time:
250.000.000 fps
This 4 image sequence can be
repeated every 9.6 ms

double image mode 8 images of 20 ns exposure time
with 60 ns interframing time:
12.500.000 fps
This 8 image sequence can be
repeated every 38.4 ms

» image intensifier 4x

type	HighRes micro channel plate (MCP) 6 µm channel
input window	synthetic silica, borosilicate
photocathode material	S20, GaAs, GaAsP (others on request)
image intensifier pitch distance	6 µm
image intensifier MCP type	single stage low resistance MCP for high strip current
MCP operational modes	continuous gated for enhanced extinction ratio
image intensifier diameter	25 mm (18 mm optional on request)
phosphor screen material	P43, P46
output window	glass
image intensifier system resolution	> 50 lp/mm @ 5 % MTF typical (depends on phosphor)
shortest gating time	4 ns

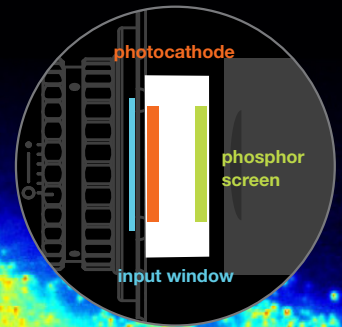

» image intensifier input window

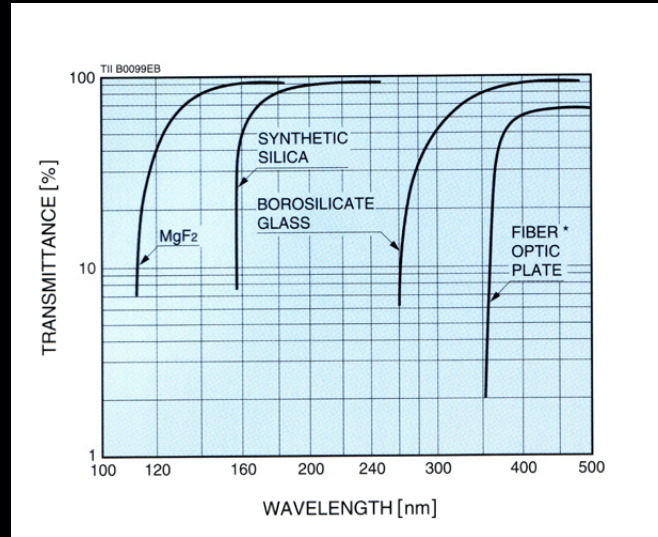

Typical transmittance of image intensifier input window materials

Due to the optical properties of the beam-splitter optics, there is no uv transmission below 380 nm. Intensifiers with MgF₂ input window are not available. Standard input window for S20 photocathodes is synthetic silica.

GaAs and GaAsP photocathodes are deposited on borosilicate glass.

» image intensifier photocathode characteristics

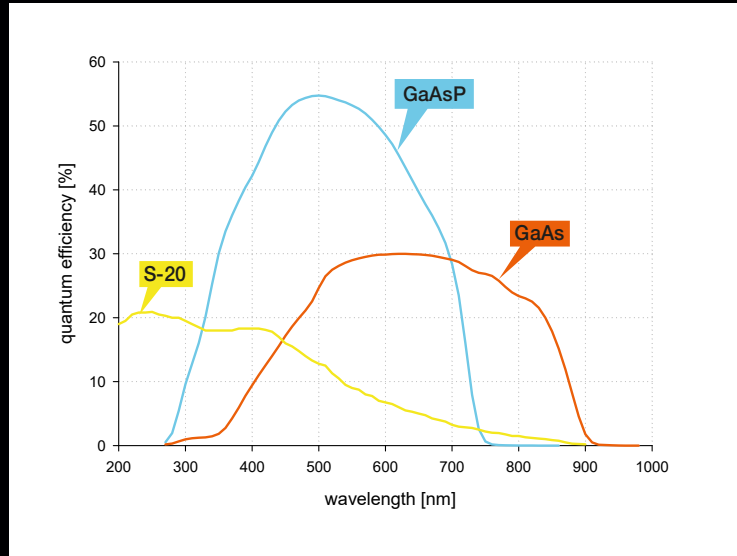

Spectral sensitivities of different photocathode materials: S20 (multialkali), GaAs, GaAsP

data courtesy of Hamamatsu Photonics

photocathode material	peak wavelength [nm]	typical quantum efficiency at peak wavelength [%]	dark counts [s ⁻¹ /cm ²]
S20 (multialkali)	250	20	1500
GaAs	650	30	30 000
GaAsP	500	55	10 000

data courtesy of Hamamatsu Photonics

» image intensifier phosphor

phosphor	phosphor decay (typ.) to..		peak emission	typical efficiency
	.. 10%	.. 1 %		
P43	1 ms	4 ms	545 nm	100 %
P46	0.2 - 0.4 μs	2 μs	530 nm	30 %

You can combine all photocathode materials with P43 or P46 phosphor. Whereas the P43 phosphor has a much brighter emission than the P46 phosphor, it has a rather long decay time, i.e. the time required till the phosphor emission fades out after the excitation by electron bombardement has been stopped. This decay time is therefore critical for fast image repetition rates primarily in double image application or when operating the camera in spectroscopic mode with line rates in the kHz range.

» optical coupling lens system of the detector units

ultra-speed tandem lens between image intensifier & sCMOS

transmission efficiency	> 30 %
vignetting	< 3 %
resolution	> 60 lp/mm
scaling rates	$\beta=0.53$ for 25 mm intensifier

2048

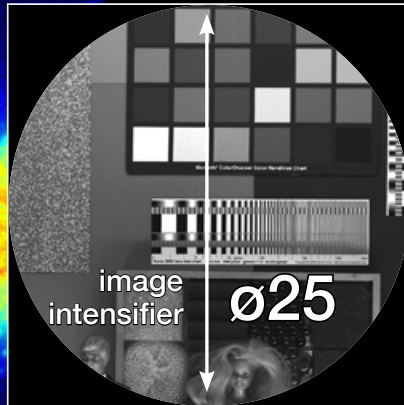

2048

The projected image circle is completely covered by 2048 x 2048 6.5 μm pixels of the sCMOS detector – cf. image left. There is no “waste” of valuable intensifier area. As a consequence the four corners of the sCMOS sensor remain black. For a fast scan of just a few vertically centered lines - the camera module allows you to achieve more than 27.000 fps for such a ROI - the full line length of 2048 pixels is available.

» camera interface

4x



data transfer	Camera Link HS, FOL (Single F2, 1X1, S10) single 4 port frame grabber for PCI Express
maximum cable length	10 km
master input signals	optical trigger (FOL), electrical trigger, arm input (TTL level, BNC connectors)
additional input signals per channel	electrical trigger, arm input (TTL level, BNC connectors), gate disable (high-speed TTL input, BNC connectors)
additional output signals per channel	gate/expos out monitor, user monitor output (TTL level, BNC connectors)

» lens remote controller

The optional Canon lens controller enables you to connect electronic EF- and EF-S Canon lenses allowing to remote control focus and aperture of those lenses.

» dimensions

Camera equipped with F-mount lens adapter. All dimensions are given in millimeter.

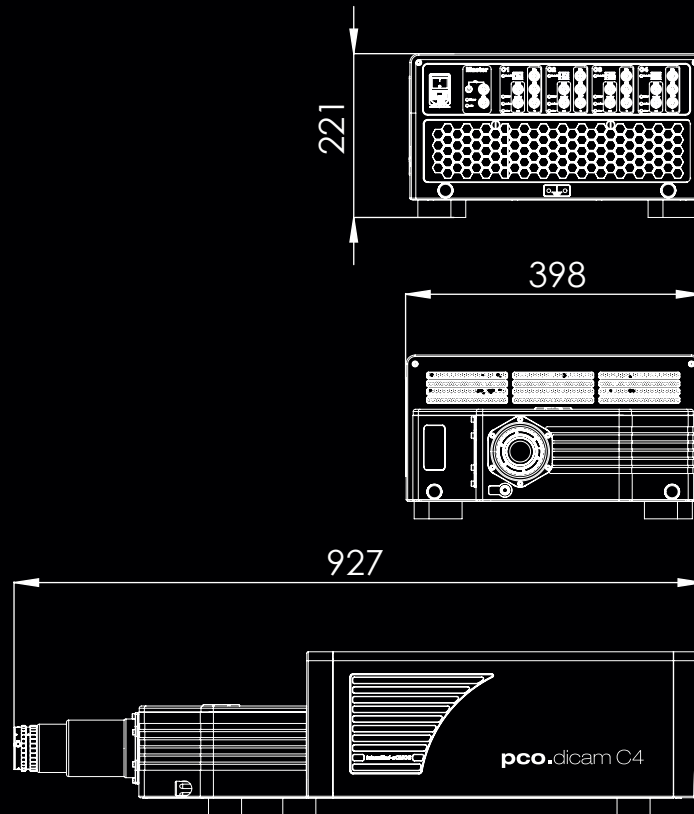

» camera view



» applications

laser induced incandescence (LII) | shock wave physics | laser induced breakdown spectroscopy (LIBS) | particle image velocimetry (PIV) | time resolved spectroscopy | plasmaphysics | laser induced fluorescence (LIF) | ballistics | combustion

» software

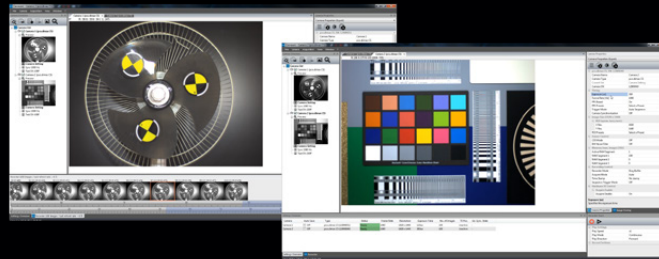

With pco.camware you control all camera settings, the image acquisition and the storage of your image data. The pco.sdk is the complementary software development kit. It includes dynamic link libraries for user customization and integration on Windows-PC platforms. Drivers for popular third party software packages are also available for you.

All this items like pco.camware, pco.sdk and third party drivers, are free-to-download at www.pco.de.

» third party integrations



» possible combinations

photocathode	input window	phosphor
S20 selected	synthetic silica	P46
		P43
GaAs standard	borosilicate	P46
		P43
GaAs selected	borosilicate	P46
		P43
GaAsP standard	borosilicate	P46
		P43
GaAsP selected	borosilicate	P46
		P43

Please note that P43 phosphor can't be used, if 8 fast images with interframing times << 1 ms are required.

Image intensifiers with GaAs and GaAsP photocathode are available in two quality grades:

- Standard: quality specified for central 16 mm x 16 mm square region corresponding to 1300 x 1300 pixel sCMOS sensor resolution
- Selected: quality specified for 24.9 mm diameter area corresponding to full 2048 x 2048 pixel sCMOS sensor resolution, extinction ratio 10 times higher than standard grade, image intensifiers with S20 photocathode exclusively come in selected grade quality, contact our technical sales team for further details on the two quality grades

» select optical interface

F-mount
EF lens control

» select FOL

type of data interface FOL module in camera and frame grabber

SM SFP+ up to 10 km
MM SFP+ up to 300 m

FOL cable length default: 10 m

Need more help?
Get in touch with our experts, tell us what you want to achieve and let us help you find the best customization for your application!

contact

europa (HQ)

PCO AG
Donaupark 11
93309 Kelheim, Germany

+49 9441 2005 50
info@pco.de
pco.de

america

PCO-TECH Inc.
1000 N West Street, Suite 1200
Wilmington, DE 19801

+1 866 678 4566
info@pco-tech.com
pco-tech.com

asia

PCO Imaging Asia Pte.
3 Temasek Ave
Centennial Tower, Level 34
Singapore, 039190

+65 6549 7054
info@pco-imaging.com
pco-imaging.com

china

Suzhou PCO Imaging Technology Co., Ltd.
Room A10, 4th Floor, Building 4
Ascendas Xinsu Square, No. 5 Xinghan Street
Suzhou Industrial Park, China 215021

+86 512 67634643
info@pco.cn
pco.cn



for application stories
please visit our website



pco.

subject to changes without prior notice | lens is sold separately
©PCO AG, Kelheim | pco.dicam C4 data sheet | v2.14

ISO 9001:2015