

Pixelink®

A NANITAR COMPANY









PL-D7512

CMOS | SONY IMX253 | GLOBAL SHUTTER

The PL-D family of cameras links together the benefits of high frame rate CMOS technology with the high speed data throughput of USB 3.0 technology. The PL-D7512 camera provides low noise images for outstanding value for a broad range of industrial applications.



KEY FEATURES

12.29MP CMOS	 33 FRAMES Per Sec.	 3.45µm	 17.6mm	 Sensor Size 1.1"
 12 BIT	 COLOR	 MONO	 USB 3	

TYPICAL APPLICATIONS

Parts inspection
Strength Testing
Metrology

Biometrics
Medical Imaging
PCB & Flat Panel Display Inspection

TECHNICAL SPECIFICATIONS

SENSOR

Sensor	Sony IMX253
Type	CMOS Global Shutter
Resolution	12.29 MP (4096 x 3000)
Pixel Pitch	3.45 µm x 3.45 µm
Active Area	17.6 mm diagonal

PERFORMANCE SPECIFICATIONS

FPN	< 0.03% of signal
PRNU	< 0.4% of signal
Dynamic Range	70 dB
Bit Depth	8 or 12-bit
Color Data Formats	Bayer 8, Bayer 12 Packed, Bayer 16 & YUV422
Mono Data Formats	Mono 8, Mono 12 Packed & Mono 16

FRAME RATES

Resolution	Free Running
4096 x 3000	32.5 fps
1280 x 1024	98.4 fps
640 x 480	198.6 fps
Frame rates will vary based on host system and configuration	
*Above calculations based on fixed frame rate mode	

INTERFACES

Interface Data rate	USB 3.0 Micro-B 5Gbps
Board Level Trigger Connector	8-pin Molex 1.25mm pitch
Enclosed Trigger Connector	Hirose round 8-pin
Trigger	Software and hardware
Board Level Trigger Input	1 input, 3.3V (with internal pullup resistor)
Enclosed Trigger Input	1 optically isolated, 5-12V DC at 4-11 mA
Board Level GPO/Strobe	2 outputs, 3.3V
Enclosed GPO/Strobe	2 outputs, 3.3V and 1 optically isolated max 40V DC, max 15mA
GPI	1 input, 3.3V (with internal pullup resistor)

MECHANICALS

Dimensions (mm)	55 x 38.5 x 30.29
Weight (g)	35.8 (Board level without optics)
Mounting	C-Mount

POWER REQUIREMENTS

Voltage Required	5V DC (from USB connector)
------------------	----------------------------

PIN NAME & FUNCTION

1	3.3V power output
2	TRIGGER/GPI 3.3V HCMOS input
3	Ground
4	GPO1, 3.3V HCMOS output
5	GPO2, 3.3V HCMOS output
6	Clock, 3.3V (I2C access for OEMs)
7	Data, 3.3V (I2C access for OEMs)
8	No connection
Board connector: Molex (8-pin, 1.25mm pitch, vertical); Cable receptacle: Molex 51021-0800; Cable crimp terminals: Molex 50079-8100	

ENCLOSED GPIO INTERFACE PIN OUTPUT DESCRIPTION

1	VBUS (Power output from USB3 cable)
2	TRIGGER + (optically isolated)
3	TRIGGER - (optically isolated)
4	GPO1 + (optically isolated)
5	GPO1 - (optically isolated)
6	GPO1, 3.3V HCMOS output (I2C - SCL for autofocus)
7	GPO2, 3.3V HCMOS output (I2C - SDA for autofocus)
8	Ground (logic and chassis ground)

ENVIRONMENTAL & REGULATORY

Compliance	FCC, CE & RoHS
Shock & Vibration	300 G & 20 G (10Hz - 2KHz)
Operating Temperature	0°C to 50°C
Storage Temperature	-45°C to 85°C

SOFTWARE

Pixelink Capture	Control & operate multi-camera
Pixelink SDK	Software Development Kit
Pixelink µScope	Acquisition, analysis & reporting
3rd. Party U3V Vision Applications	

COMPUTER & OPERATING SYSTEM

	Windows	Linux x86	Linux ArmV7	Linux ArmV8
Processor	Intel i5 or better	Intel i5 or better	Arm7 (32 bit)	Arm8 (64 bit)
Memory	4GB recommended	4GB recommended	2GB	2GB
Hard Drive Space	150 MB	150 MB	50 MB	50 MB
Operating System	Windows 7/8/10	Ubuntu 14.04/16.04 Desktop	Ubuntu 14.04/16.04	Ubuntu 14.04/16.04

MECHANICAL DRAWINGS & RESPONSIVITY CURVES

MECHANICAL DRAWINGS

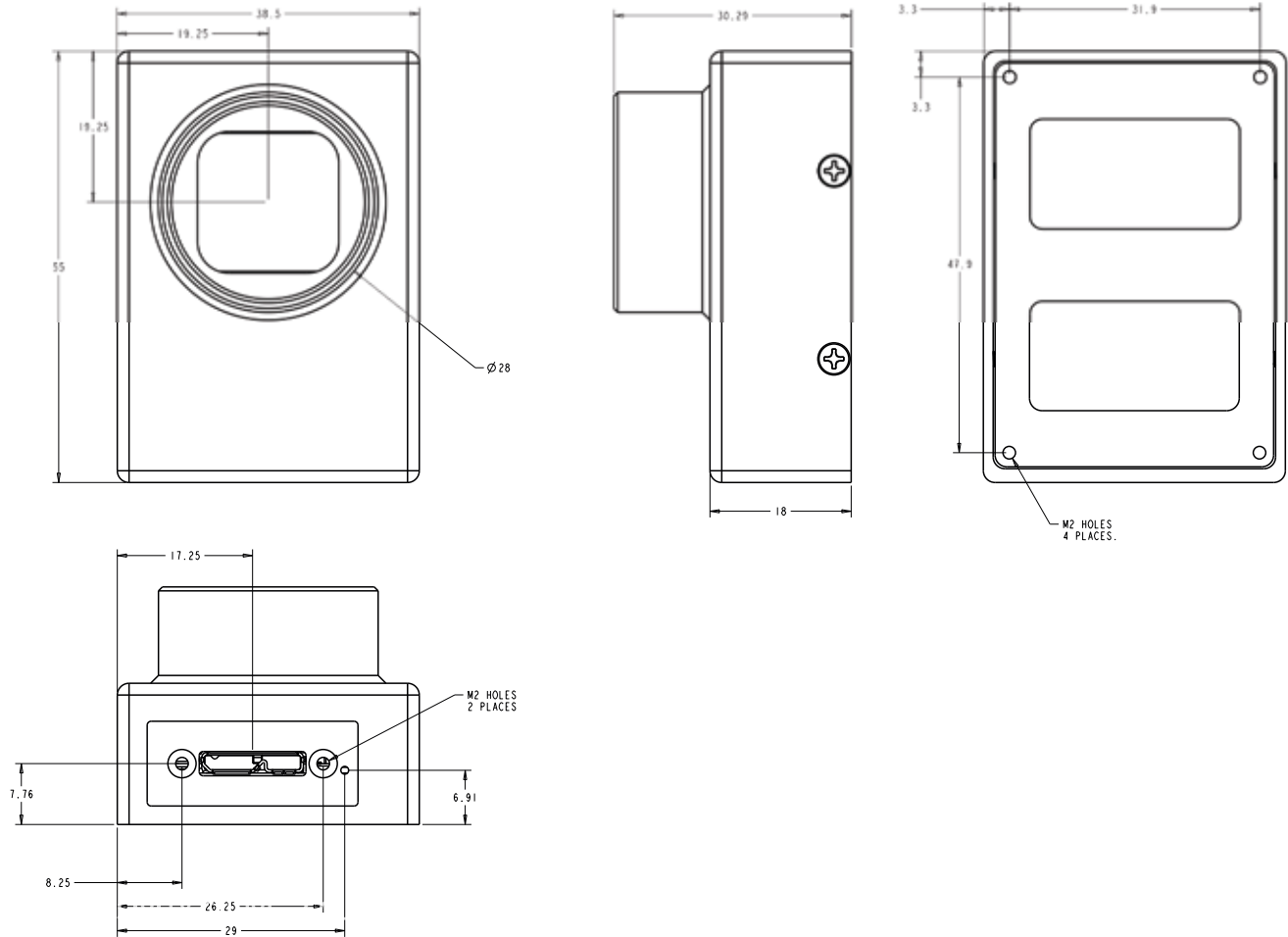

RESPONSIVITY CURVE - COLOR

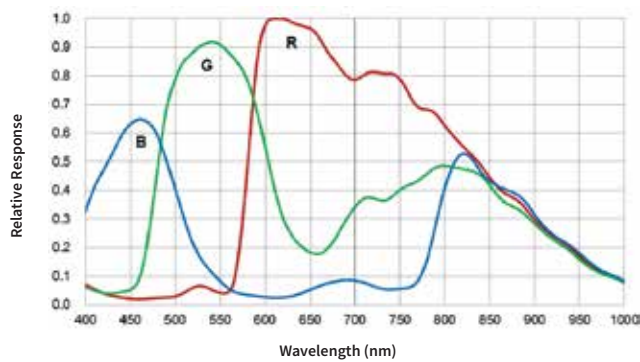

RESPONSIVITY CURVE - MONO

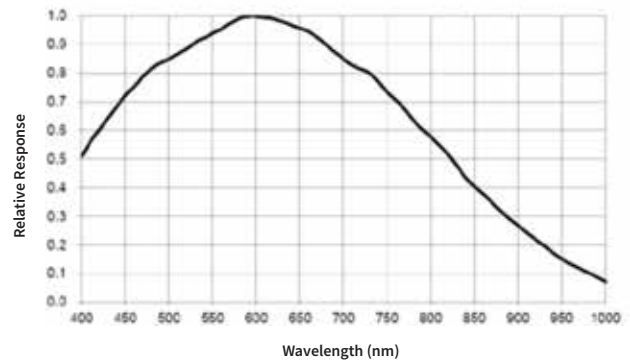

PIXELINK'S INDUSTRY LEADING SOFTWARE

PIXELINK CAPTURE

Pixelink Capture is powerful multi-camera software application designed to configure "n" numbers of cameras and stream "n" number of cameras simultaneously in real-time high-quality video viewed in a multi-window environment. Pixelink Capture offers options for complex image enhancements such as; exposure control, filtering, frame-by-frame property changes in addition to multi-camera application testing and configuration.

Pixelink Capture also provides features to measure supporting; point, line, circle, rectangle, polyline and polygon measurements while determining pixel location. After creating spatial calibration, the user can then review and adjust before exporting the findings to an Excel spreadsheet for further analysis. Pixelink Capture also has integrated lens control (zoom & focus) for Navitar motorized lenses and accurate autofocus options for Navitar motorized fine focus mechanisms.

Visit pixelink.com for more detailed information.

PIXELINK SDK

Providing full control of all camera functions, the Pixelink Software Developers Kit (SDK) is the software package of choice for developers and system integrators who are integrating Pixelink cameras into their applications. The Pixelink SDK provides access to the full Pixelink Application Programming Interface (API) and provides sample applications, wrappers for many 3rd party controls, such as LabVIEW, along with full documentation.

The Pixelink SDK is compatible with Microsoft Windows and popular Linux platforms. When using the Pixelink SDK, developers can integrate Pixelink cameras into their custom applications with ease.

Visit pixelink.com for more detailed information.

AVAILABLE CONFIGURATIONS

PL-D7512CU
PL-D7512CU-BL
PL-D7512CU-T

PL-D7512MU
PL-D7512MU-BL
PL-D7512MU-T

Color Space
C = Color
M = Mono
NIR = Near Infrared

Interface
F = Firewire
G = GigE
U = USB

Housing
CS = CS Mount
S-BL = S Mount Board Level
BL = Board Level
T = Trigger